

R-SERIES REFLEX LEVEL GAUGES

Reflex indicators display the fluid level through a transparent surface being part of a column that is connected to the vessel by on-off cock gauges.

The measuring part is composed of one or more elements from prismatic borosilicate glass (crystal) which trigger the reflection or non-reflection of the environmental light depending on whether the inner surface comes or does not come into contact with the fluid or with the gas (vapour).

The crystal is tightened to the inside of a steel box by means of bolts.

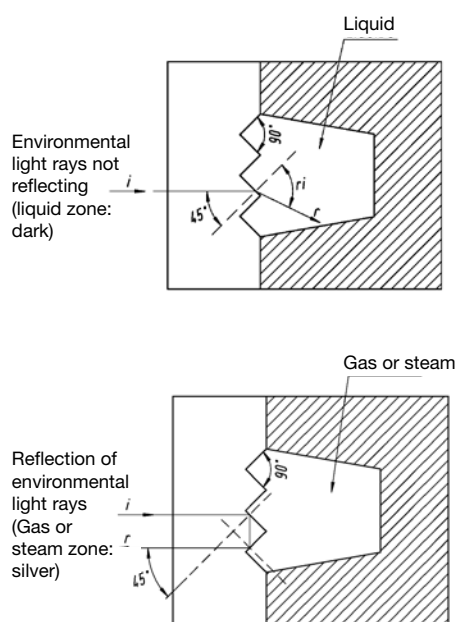

Its sturdy construction and its good visibility, without using dedicated illuminators, make it ideal for use in heavy-duty applications with pressure up to 400 bars and temperature up to 427° C.

APPLICATIONS AND TECHNICAL DATA

Reflex level indicators are used in various industrial processes, especially in the chemical, petrochemical, power production, metal and steel, water treatment, food, paper industries and the like.

They are typically preferred to transparency indicators in application on clear and non-corrosive fluids.

Versions with body and wetted parts in galvanized Carbon Steel are available, whereas AISI 316, ASTM LF2, Hastelloy and other materials are available upon request.

The standard versions feature the following rating:

- PN 40 (mod. RBB)
- PN 64 (mod. RMB)
- PN 100 (mod. RAC)
- PN 160 (mod. RHC)
- PN 250 (mod. RHH)
- PN 400 (mod. RHX)
- PN 64 - Large chamber (mod. RLB)



OPTIONS

- Safety ball check in AISI 316 (in the event of the crystal getting broken, it avoids fluid losses)
- Graduated scale
- Uninterrupted visibility
- Drain and vent valves
- Top / Bottom connections
- No-Frost device
- Electric or steam tracer
- Aluminosilicate glasses
- Screws and cock levers in AISI 316, for off-shore use

MOD. RBB (PN 40) REFLEX INDICATOR

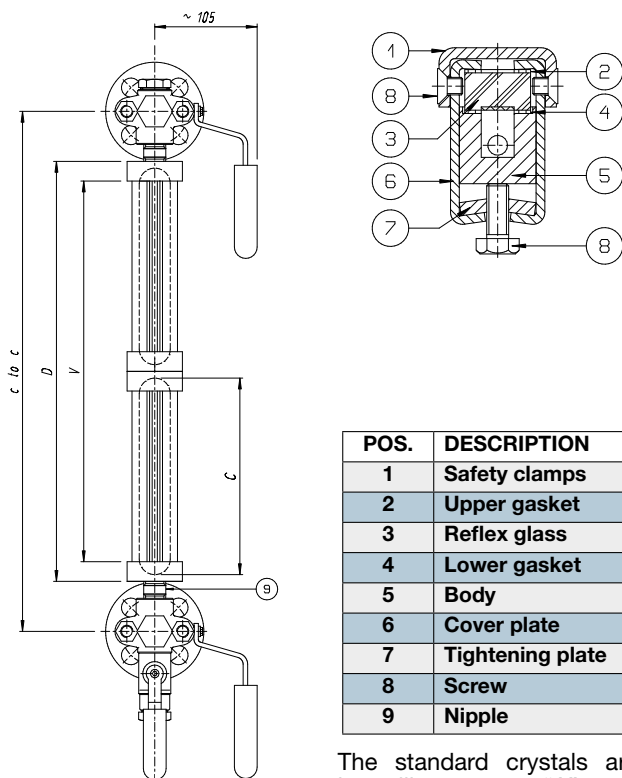

POS.	DESCRIPTION
1	Safety clamps
2	Upper gasket
3	Reflex glass
4	Lower gasket
5	Body
6	Cover plate
7	Tightening plate
8	Screw
9	Nipple

The standard crystals are in borosilicate, type "A" 30 mm width.

Mis.	C to C min. (x NX)	C to C min. (x NY)	D	V	C
13	285	246	178	141	165
14	310	271	203	166	190
15	340	301	233	196	220
16	370	331	263	226	250
17	400	361	293	256	280
18	440	401	333	296	320
19	460	421	353	313	340
24	515	474	406	367	190
25	575	534	466	427	220
26	635	594	526	489	250
27	695	654	586	549	280
28	775	734	666	628	320
29	815	774	706	668	340
36	900	857	789	751	250
37	990	947	879	841	280
38	1110	1067	999	961	320
39	1170	1127	1059	1021	340
47	1285	1240	1172	1134	280
48	1445	1400	1332	1294	320
49	1525	1480	1412	1374	340
57	1580	1533	1465	1427	280
58	1780	1733	1665	1627	320
59	1880	1833	1765	1727	340
68	2115	2066	1998	1960	320
69	2235	2186	2118	2080	340
79	2590	2539	2471	2433	340

MOD. RMB (PN 64) REFLEX INDICATOR

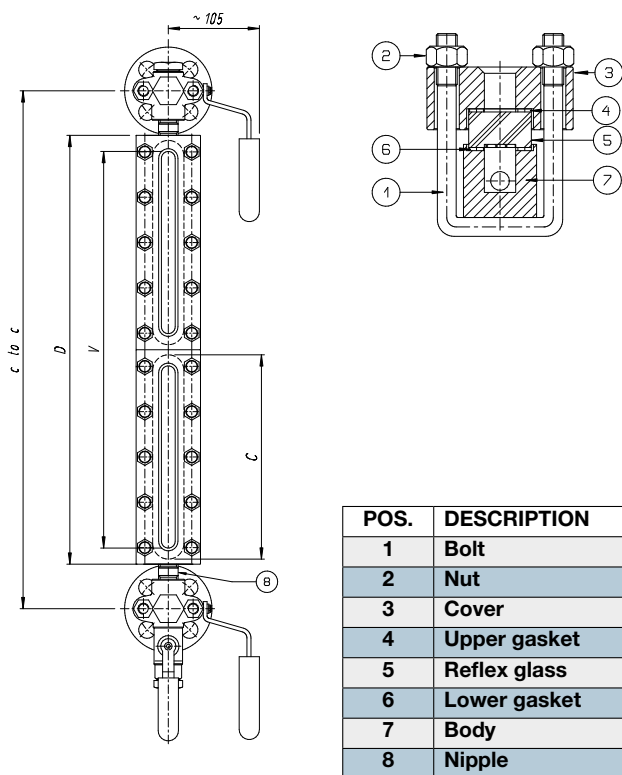

POS.	DESCRIPTION
1	Bolt
2	Nut
3	Cover
4	Upper gasket
5	Reflex glass
6	Lower gasket
7	Body
8	Nipple

The standard crystals are in borosilicate, type "A" 30 mm width.

Mis.	C to C min. (x NY)	D	V	C
11	196	128	91	115
12	221	153	116	140
13	246	178	141	165
14	271	203	166	190
15	301	233	196	220
16	331	263	226	250
17	361	293	256	280
18	401	333	296	320
19	421	353	313	340
24	474	406	367	190
25	534	466	427	220
26	594	526	489	250
27	654	586	549	280
28	734	666	628	320
29	774	706	668	340
36	857	789	751	250
37	947	879	841	280
38	1067	999	961	320
39	1127	1059	1021	340
47	1240	1172	1134	280
48	1400	1332	1294	320
49	1480	1412	1374	340
57	1533	1465	1427	280
58	1733	1665	1627	320
59	1833	1765	1727	340
68	2066	1998	1960	320
69	2186	2118	2080	340
79	2539	2471	2433	340

MOD. RAC (PN100) REFLEX INDICATOR

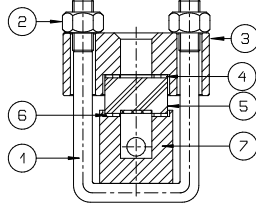
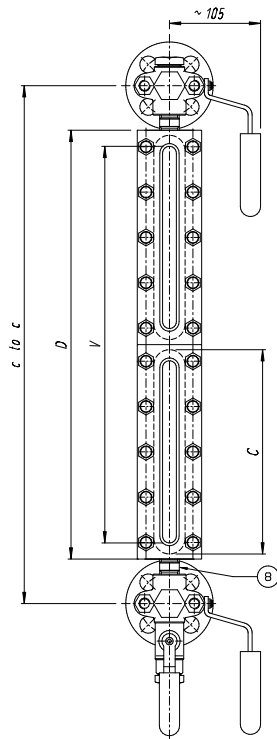

POS.	DESCRIPTION
1	Bolt
2	Nut
3	Cover
4	Upper gasket
5	Reflex glass
6	Lower gasket
7	Body
8	Nipple

The standard crystals are in borosilicate, type "B" 34 mm width.

Mis.	C to C min. (x NY)	D	V	C
11	196	128	91	115
12	221	153	116	140
13	246	178	141	165
14	271	203	166	190
15	301	233	196	220
16	331	263	226	250
17	361	293	256	280
18	401	333	296	320
19	421	353	313	340
24	474	406	367	190
25	534	466	427	220
26	594	526	489	250
27	654	586	549	280
28	734	666	628	320
29	774	706	668	340
36	857	789	751	250
37	947	879	841	280
38	1067	999	961	320
39	1127	1059	1021	340
47	1240	1172	1134	280
48	1400	1332	1294	320
49	1480	1412	1374	340
57	1533	1465	1427	280
58	1733	1665	1627	320
59	1833	1765	1727	340
68	2066	1998	1960	320
69	2186	2118	2080	340
79	2539	2471	2433	340

MOD. RHC (PN160) REFLEX INDICATOR

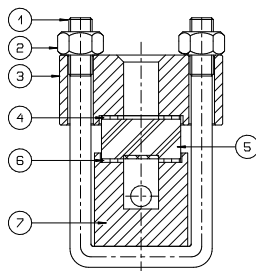
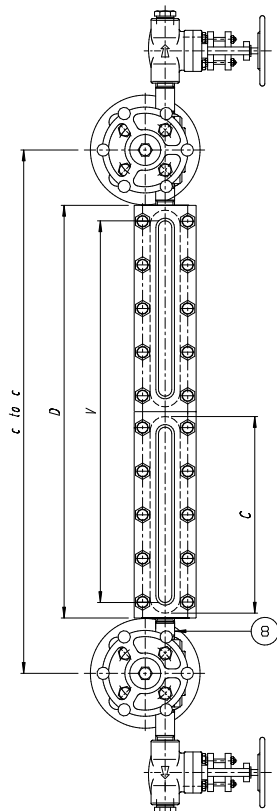

POS.	DESCRIPTION
1	Bolts
2	Nut
3	Cover
4	Upper gasket
5	Reflex glass
6	Lower gasket
7	Body
8	Nipples

The standard crystals are in borosilicate, type "B" 34 mm width.

Mis.	C to C min. (x YY)	C to C min. (x YX)	D	V	C
11	216	265	128	91	115
12	241	290	153	116	140
13	266	315	178	141	165
14	291	340	203	166	190
15	321	370	233	196	220
16	351	400	263	226	250
17	381	430	293	256	280
18	421	470	333	296	320
19	441	490	353	313	340
24	494	543	406	367	190
25	554	603	466	427	220
26	614	663	526	489	250
27	674	723	586	549	280
28	754	803	666	628	320
29	794	843	706	668	340
36	877	926	789	751	250
37	967	1016	879	841	280
38	1087	1136	999	961	320
39	1147	1196	1059	1021	340
47	1260	1309	1172	1134	280
48	1420	1469	1332	1294	320
49	1500	1549	1412	1374	340
57	1553	1602	1465	1427	280
58	1753	1802	1665	1627	320
59	1853	1902	1765	1727	340
68	2086	2135	1998	1960	320
69	2206	2255	2118	2080	340
79	2559	2608	2471	2433	340

MOD. RHH (PN 250) REFLEX INDICATOR

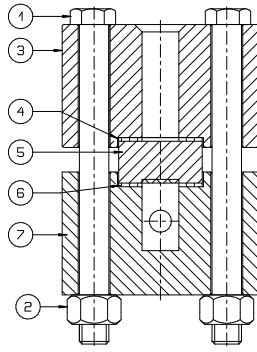
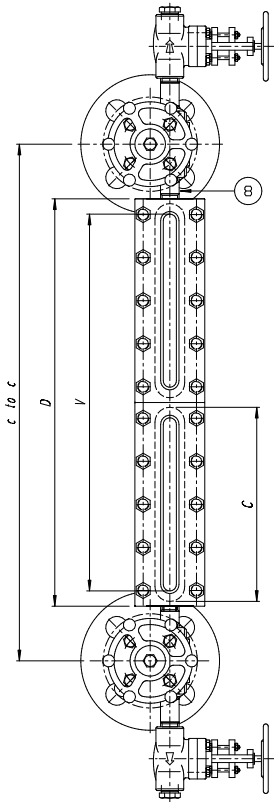

POS.	DESCRIPTION
1	Screw
2	Nut
3	Cover
4	Upper gasket
5	Reflex glass
6	Lower gasket
7	Body
8	Nipple

The standard crystals are in borosilicate, type "B" 34 mm width.

Mis.	C to C min. (x YY)	C to C min. (x YX)	D	V	C
11	216	265	128	91	115
12	241	290	153	116	140
13	266	315	178	141	165
14	291	340	203	166	190
15	321	370	233	196	220
16	351	400	263	226	250
17	381	430	293	256	280
18	421	470	333	296	320
19	441	490	353	313	340
24	494	543	406	367	190
25	554	603	466	427	220
26	614	663	526	489	250
27	674	723	586	549	280
28	754	803	666	628	320
29	794	843	706	668	340
36	877	926	789	751	250
37	967	1016	879	841	280
38	1087	1136	999	961	320
39	1147	1196	1059	1021	340
47	1260	1309	1172	1134	280
48	1420	1469	1332	1294	320
49	1500	1549	1412	1374	340
57	1553	1602	1465	1427	280
58	1753	1802	1665	1627	320
59	1853	1902	1765	1727	340
68	2086	2135	1998	1960	320
69	2206	2255	2118	2080	340
79	2559	2608	2471	2433	340

MOD. RHX (PN 400) REFLEX INDICATOR

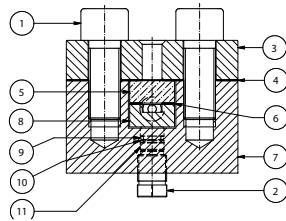
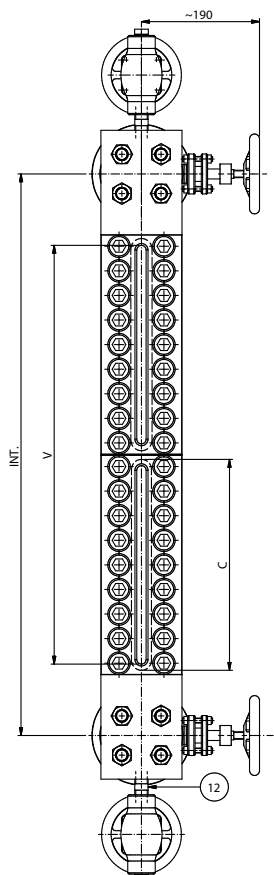

POS.	DESCRIPTION
1	Screw
2	Pressure screw
3	Cover
4	Gasket
5	Reflex glass
6	Glass gasket
7	Body
8	Pressure plate
9	O ring gasket
10	Sealing ring
11	Pressure piece
12	Nipple

The standard crystals are in borosilicate, type "B" 34 mm width.

Mis.	C to C min. (x ZY)	V	C
13	331	141	165
14	356	166	190
15	386	196	220
16	416	226	250
17	446	256	280
18	486	296	320
19	506	313	340
24	571	367	190
25	644	427	220
26	717	489	250
27	747	549	280
28	830	628	320
29	893	668	340
36	1018	751	250
37	1048	841	280
38	1174	961	320
39	1280	1021	340
47	1349	1134	280
48	1518	1294	320
49	1650	1374	340
57	1667	1427	280
58	1862	1627	320
59	2054	1727	340
68	2206	1960	320
69	2441	2080	340
79	2828	2433	340

MOD. RLB (PN 64) - LARGE CHAMBER REFLEX INDICATOR

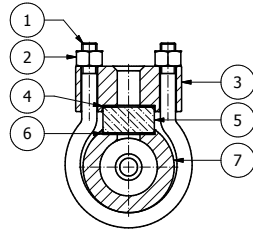
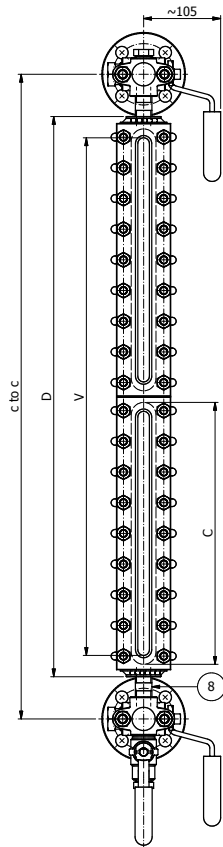

POS.	DESCRIPTION
1	Bolt
2	Nut
3	Cover
4	Lower gasket
5	Reflex glass
6	Upper gasket
7	Body
8	Nipple

The standard crystals are in borosilicate, type "B" 34 mm width.

Mis.	C to C min. (x NY)	D	V	C	C
12	258	168	116	140	165
13	283	193	141	165	190
14	308	218	166	190	220
15	338	248	196	220	250
16	368	278	226	250	280
17	398	308	256	280	320
18	438	348	296	320	340
19	458	368	313	340	190
24	513	423	367	190	220
25	573	483	427	220	250
26	633	543	489	250	280
27	693	603	549	280	320
28	773	683	628	320	340
29	813	723	668	340	250
36	898	808	751	250	280
37	988	898	841	280	320
38	1108	1018	961	320	340
39	1168	1078	1021	340	280
47	1283	1193	1134	280	320
48	1443	1353	1294	320	340
49	1523	1433	1374	340	280
57	1578	1488	1427	280	320
58	1778	1688	1627	320	340
59	1878	1786	1727	340	320
68	2113	2023	1960	320	340
69	2233	2143	2080	340	340



GENERAL FEATURES SHARED BY ALL MODELS:

- The connections between the level and the cocks are made by screwed nipples (NY or YY) or by end tubes and stuffing boxes (NX or NY) or with flange ZY.
- Gauge connections 1/2".
- The position of the lever cock handles can be Right or Left.
- Process connections can be flanged (UNI - ANSI - DIN), threaded (GAS M / F - NPT M / F) and Socket Welding (SW).
- Graphoil gasket.
- The carbon steel body is galvanized by electrolysis.
- Body painted can be supplied on request.

HOW TO ORDER

MODEL						
PN 40	PN 64	PN 100	PN 160	PN 250	PN 400	PN 64 - Large chamber
RBB	RMB	RAC	RHC	RHH	RHX	RLB

	<table border="1" style="width: 100%; border-collapse: collapse; text-align: center;"> <tr><td>SIZE</td></tr> <tr><td>see table</td></tr> </table>	SIZE	see table														
SIZE																	
see table																	
		<table border="1" style="width: 100%; border-collapse: collapse; text-align: center;"> <tr><td colspan="5">CONNECTIONS</td></tr> <tr> <td>Threaded nipples</td> <td>End tubes and stuffing boxes</td> <td>Threaded nipples for high pressure</td> <td>Union nipple (rotatable) for high pressure</td> <td>Flange</td> </tr> <tr> <td>NY</td> <td>NX</td> <td>YY</td> <td>YX</td> <td>ZY</td> </tr> </table>	CONNECTIONS					Threaded nipples	End tubes and stuffing boxes	Threaded nipples for high pressure	Union nipple (rotatable) for high pressure	Flange	NY	NX	YY	YX	ZY
CONNECTIONS																	
Threaded nipples	End tubes and stuffing boxes	Threaded nipples for high pressure	Union nipple (rotatable) for high pressure	Flange													
NY	NX	YY	YX	ZY													
		<table border="1" style="width: 100%; border-collapse: collapse; text-align: center;"> <tr><td colspan="3">BODY MATERIAL</td></tr> <tr> <td>Carbon Steel</td> <td>AISI 316</td> <td>A350 gr.6</td> </tr> <tr> <td>A</td> <td>J</td> <td>LF2</td> </tr> </table>	BODY MATERIAL			Carbon Steel	AISI 316	A350 gr.6	A	J	LF2						
BODY MATERIAL																	
Carbon Steel	AISI 316	A350 gr.6															
A	J	LF2															
		<table border="1" style="width: 100%; border-collapse: collapse; text-align: center;"> <tr><td colspan="2">CONNECTIONS POSITION</td></tr> <tr> <td>SIDE-SIDE</td> <td>TOP-BOTTOM</td> </tr> <tr> <td>LL</td> <td>TB</td> </tr> </table>	CONNECTIONS POSITION		SIDE-SIDE	TOP-BOTTOM	LL	TB									
CONNECTIONS POSITION																	
SIDE-SIDE	TOP-BOTTOM																
LL	TB																
		<table border="1" style="width: 100%; border-collapse: collapse; text-align: center;"> <tr><td>SPECIAL VERSION</td></tr> </table>	SPECIAL VERSION														
SPECIAL VERSION																	
RBB	47	NY	A	LL	XX												

The following data are also requested:
 Fluid, operating temperature and pressure and the connections distance.



OFFICINE OROBICHE S.p.A.

24010 Ponteranica (Bergamo) ITALY - via Serena, 10 - Tel. 0039.035.4530.211 - Fax 0039.035.570546
 www.officineorobiche.it e-mail: info@officineorobiche.it

Information subject to change without prior warning