

T-SERIES TRANSPARENT LEVEL GAUGES

This type of indicators display the level of the fluid through a transparent surface, being part of a column that is connected to the vessel by on-off cock gauges.

They are composed of one or more opposed pairs from smooth borosilicate glass (crystal) that are tightened inside a steel box.

The level reading is based on a different transparency of the fluid and the gas or vapour.

In heavy-duty applications, the glass is protected by means of a mica shield, which however reduces the reading transparency. To remedy this phenomenon, special illuminators are used which exploit the total refraction / reflection effect in the fluid / gas or vapour separation surface.

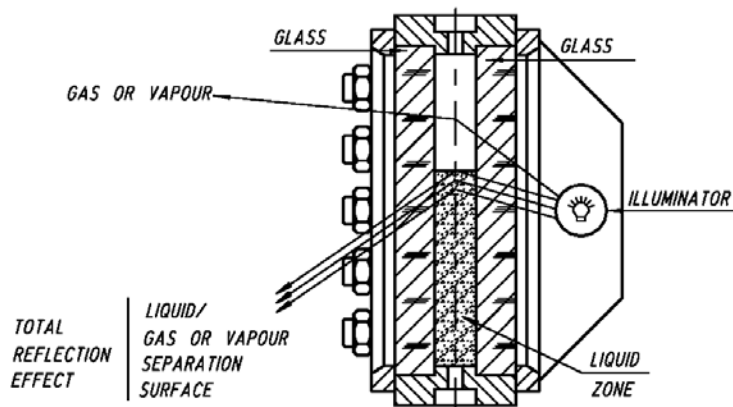

Transparent indicators are successfully used up to 250 bars and with temperatures up to 538° C.

APPLICATIONS AND TECHNICAL DATA

Transparent level indicators are used in various industrial processes, especially in the chemical, petrochemical, power production, metal and steel, water treatment, food, paper industries and the like.

They are used to carry out surveys on clear or dirty, viscous or corrosive fluids, consistently with the protective transparent material.

Versions with body and wetted parts in galvanized Carbon Steel are available, whereas AISI 316, ASTM A350 LF2, Hastelloy and other materials are available upon request.

The standard versions feature the following rating:

- PN 40 (mod. TBB)
- PN 64 (mod. TMC)
- PN 100 (mod. TAC)
- PN 160 (mod. THC)
- PN 250 (mod. THH)
- PN 64 - Large chamber (mod. TLC)

OPTIONS

- Safety ball check in AISI 316 (in the event of the crystal getting broken, it avoids fluid losses).
- Graduated scale.
- Uninterrupted visibility.
- Drain and vent valves.
- Top/Bottom connections.
- Illumination Lamp with lighting diffuser in Plexiglas or Pyrex glass.
- No-Frost device.
- Electric or steam tracer.
- Aluminosilicate or quartz glasses.

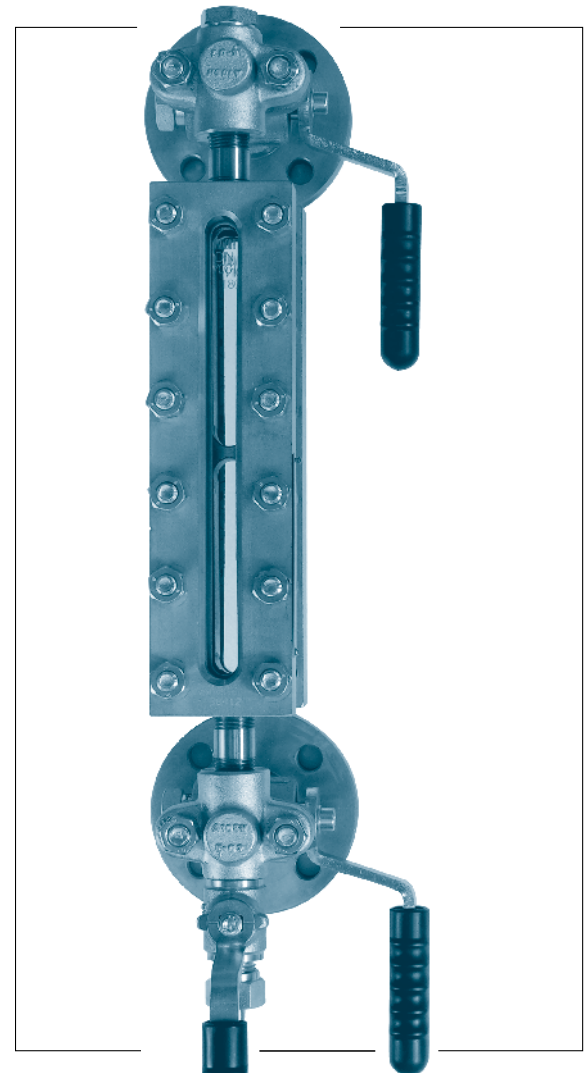

MOD. TBB (PN 40) TRANSPARENT LEVEL GAUGES

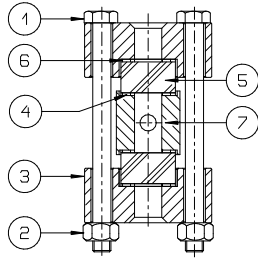
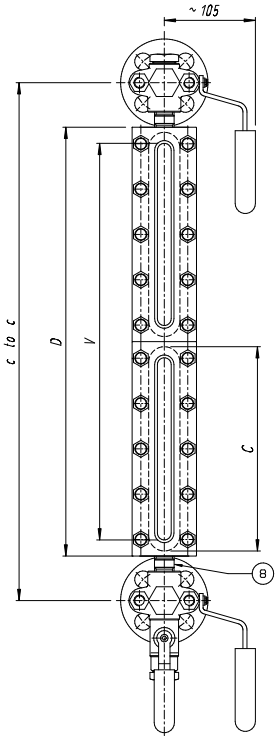

POS.	DESCRIPTION
1	Bolt
2	Nut
3	Cover
4	Lower gasket
5	Transparent glass (*)
6	Upper gasket
7	Body
8	Nipple

(*) With MICA protection if required

The standard crystals are in borosilicate, type "A" 30 mm width.

Mis.	C to C min. (x NX)	C to C min. (x NY)	D	V	C
11	235	196	128	91	115
12	260	221	153	116	140
13	285	246	178	141	165
14	310	271	203	166	190
15	340	301	233	196	220
16	370	331	263	226	250
17	400	361	293	256	280
18	440	401	333	296	320
19	460	421	353	313	340
24	515	474	406	367	190
25	575	534	466	427	220
26	635	594	526	489	250
27	695	654	586	549	280
28	775	734	666	628	320
29	815	774	706	668	340
36	900	857	789	751	250
37	990	947	879	841	280
38	1110	1067	999	961	320
39	1170	1127	1059	1021	340
47	1285	1240	1172	1134	280
48	1445	1400	1332	1294	320
49	1525	1480	1412	1374	340
57	1580	1533	1465	1427	280
58	1780	1733	1665	1627	320
59	1880	1833	1765	1727	340
68	2115	2066	1998	1960	320
69	2235	2186	2118	2080	340
79	2590	2539	2471	2433	340

MOD. TMC (PN 64) TRANSPARENT LEVEL GAUGES

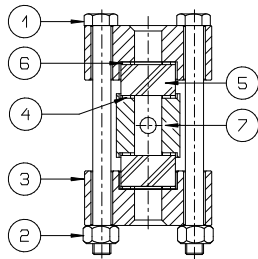
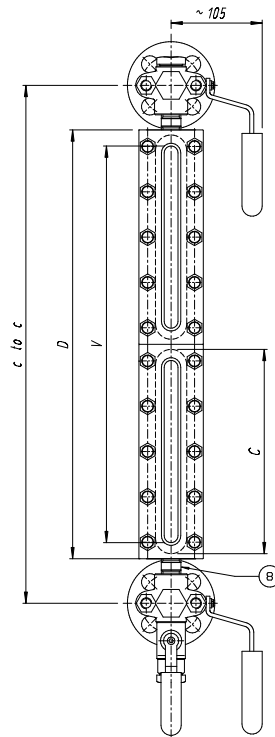

POS.	DESCRIPTION
1	Bolt
2	Nut
3	Cover
4	Lower gasket
5	Transparent glass (*)
6	Upper gasket
7	Body
8	Nipple

(*) With MICA protection if required

The standard crystals are in borosilicate, type "B" 34 mm width.

Mis.	C to C min. (x NY)	D	V	C
11	196	128	91	115
12	221	153	116	140
13	246	178	141	165
14	271	203	166	190
15	301	233	196	220
16	331	263	226	250
17	361	293	256	280
18	401	333	296	320
19	421	353	313	340
24	474	406	367	190
25	534	466	427	220
26	594	526	489	250
27	654	586	549	280
28	734	666	628	320
29	774	706	668	340
36	857	789	751	250
37	947	879	841	280
38	1067	999	961	320
39	1127	1059	1021	340
47	1240	1172	1134	280
48	1400	1332	1294	320
49	1480	1412	1374	340
57	1533	1465	1427	280
58	1733	1665	1627	320
59	1833	1765	1727	340
68	2066	1998	1960	320
69	2186	2118	2080	340
79	2539	2471	2433	340

MOD. TAC (PN 100) TRANSPARENT LEVEL GAUGES

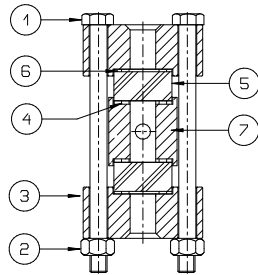
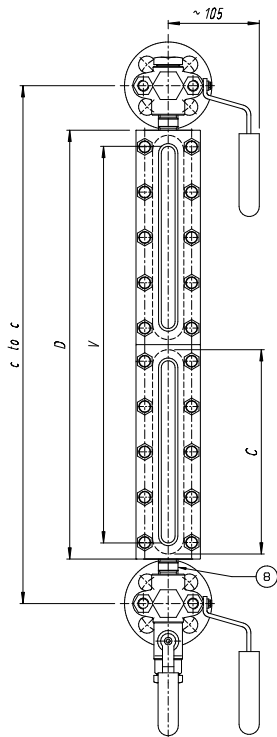

POS.	DESCRIPTION
1	Bolt
2	Nut
3	Cover
4	Lower gasket
5	Transparent glass (*)
6	Upper gasket
7	Body
8	Nipple

(*) With MICA protection if required

The standard crystals are in borosilicate, type "B" 34 mm width.

Mis.	C to C min. (x NY)	D	V	C	C
11	196	128	91	115	115
12	221	153	116	140	140
13	246	178	141	165	165
14	271	203	166	190	190
15	301	233	196	220	220
16	331	263	226	250	250
17	361	293	256	280	280
18	401	333	296	320	320
19	421	353	313	340	340
24	474	406	367	190	190
25	534	466	427	220	220
26	594	526	489	250	250
27	654	586	549	280	280
28	734	666	628	320	320
29	774	706	668	340	340
36	857	789	751	250	250
37	947	879	841	280	280
38	1067	999	961	320	320
39	1127	1059	1021	340	340
47	1240	1172	1134	280	280
48	1400	1332	1294	320	320
49	1480	1412	1374	340	340
57	1533	1465	1427	280	280
58	1733	1665	1627	320	320
59	1833	1765	1727	340	340
68	2066	1998	1960	320	320
69	2186	2118	2080	340	340
79	2539	2471	2433	340	340

MOD. THC (PN 160) TRANSPARENT LEVEL GAUGES

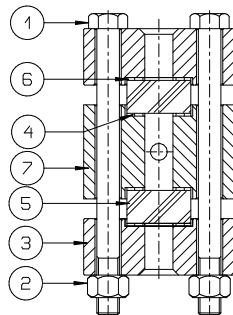
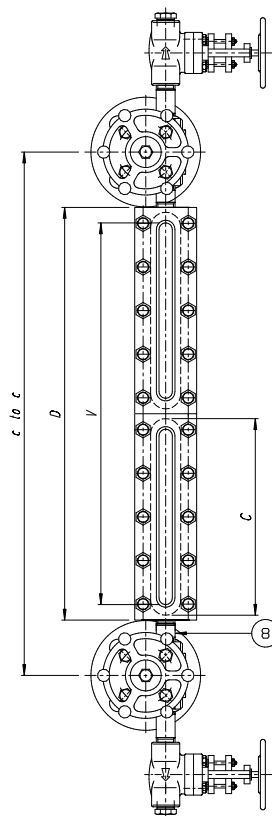

POS.	DESCRIPTION
1	Bolt
2	Nut
3	Cover
4	Lower gasket
5	Transparent glass (*)
6	Upper gasket
7	Body
8	Nipple

(*) With MICA protection if required

The standard crystals are in borosilicate, type "B" 34 mm width.

Mis.	C to C min. (x YY)	C to C min. (x YX)	D	V	C
11	216	265	128	91	115
12	241	290	153	116	140
13	266	315	178	141	165
14	291	340	203	166	190
15	321	370	233	196	220
16	351	400	263	226	250
17	381	430	293	256	280
18	421	470	333	296	320
19	441	490	353	313	340
24	494	543	406	367	190
25	554	603	466	427	220
26	614	663	526	489	250
27	674	723	586	549	280
28	754	803	666	628	320
29	794	843	706	668	340
36	877	926	789	751	250
37	967	1016	879	841	280
38	1087	1136	999	961	320
39	1147	1196	1059	1021	340
47	1260	1309	1172	1134	280
48	1420	1469	1332	1294	320
49	1500	1549	1412	1374	340
57	1553	1602	1465	1427	280
58	1753	1802	1665	1627	320
59	1853	1902	1765	1727	340
68	2086	2135	1998	1960	320
69	2206	2255	2118	2080	340
79	2559	2608	2471	2433	340

MOD. THH (PN 250) TRANSPARENT LEVEL GAUGES

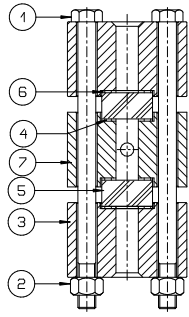
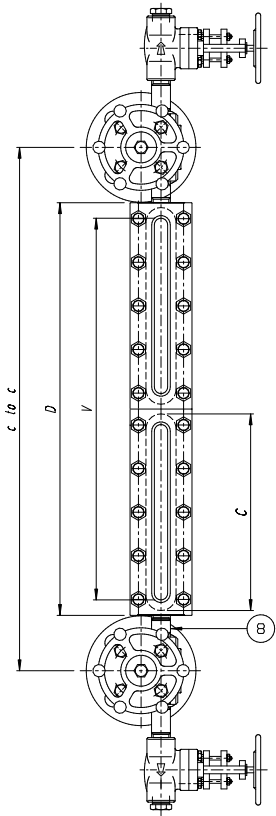

POS.	DESCRIPTION
1	Bolt
2	Nut
3	Cover
4	Lower gasket
5	Transparent glass (*)
6	Upper gasket
7	Body
8	Nipple

(*) With MICA protection if required

The standard crystals are in borosilicate, type "B" 34 mm width.

Mis.	C to C min. (x YY)	C to C min. (x YX)	D	V	C
11	216	265	128	91	115
12	241	290	153	116	140
13	266	315	178	141	165
14	291	340	203	166	190
15	321	370	233	196	220
16	351	400	263	226	250
17	381	430	293	256	280
18	421	470	333	296	320
19	441	490	353	313	340
24	494	543	406	367	190
25	554	603	466	427	220
26	614	663	526	489	250
27	674	723	586	549	280
28	754	803	666	628	320
29	794	843	706	668	340
36	877	926	789	751	250
37	967	1016	879	841	280
38	1087	1136	999	961	320
39	1147	1196	1059	1021	340
47	1260	1309	1172	1134	280
48	1420	1469	1332	1294	320
49	1500	1549	1412	1374	340
57	1553	1602	1465	1427	280
58	1753	1802	1665	1627	320
59	1853	1902	1765	1727	340
68	2086	2135	1998	1960	320
69	2206	2255	2118	2080	340
79	2559	2608	2471	2433	340

MOD. TLC (PN 64 - LARGE CHAMBER) TRANSPARENT LEVEL GAUGES

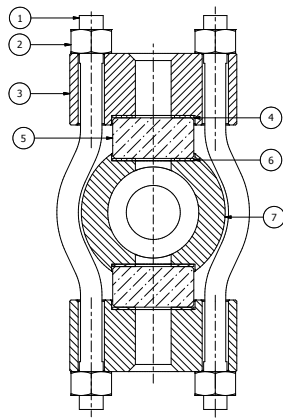
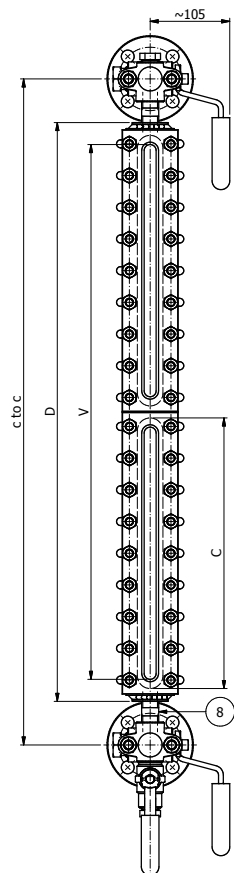

POS.	DESCRIPTION
1	Bolt
2	Nut
3	Cover
4	Lower gasket
5	Transparent glass (*)
6	Upper gasket
7	Body
8	Nipple

(*) With MICA protection if required

The standard crystals are in borosilicate, type "B" 34 mm width.

Mis.	C to C min. (x NY)	D	V	C
12	258	168	116	140
13	283	193	141	165
14	308	218	166	190
15	338	248	196	220
16	368	278	226	250
17	398	308	256	280
18	438	348	296	320
19	458	368	313	340
24	513	423	367	190
25	573	483	427	220
26	633	543	489	250
27	693	603	549	280
28	773	683	628	320
29	813	723	668	340
36	898	808	751	250
37	988	898	841	280
38	1108	1018	961	320
39	1168	1078	1021	340
47	1283	1193	1134	280
48	1443	1353	1294	320
49	1523	1433	1374	340
57	1578	1488	1427	280
58	1778	1688	1627	320
59	1878	1786	1727	340
68	2113	2023	1960	320
69	2233	2143	2080	340

ILLUMINATOR

The illuminator for **transparency** indicators allows an improved level reading in environments featuring limited luminosity.

For use in areas rated as **explosive**, only models equipped with a **Pirex** glass diffuser are used.

Single diffuser

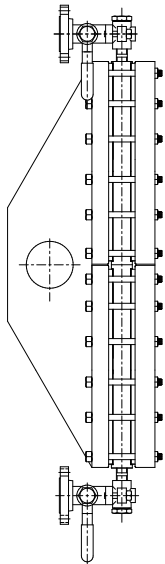

Double diffuser

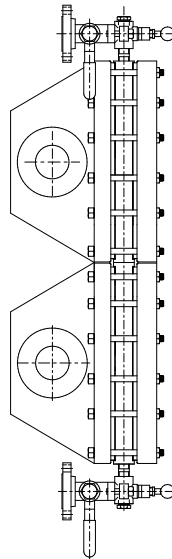

Sectional view of illuminator

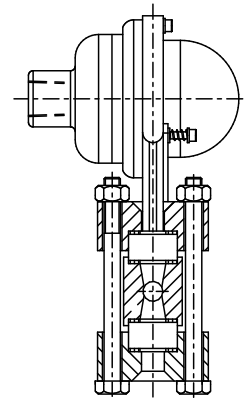

Applicability of single and double diffuser				
MEAS.	PLEXIGLASS		PIREX	
	Single	Double	Single	Double
11	N.A.	N.A.	N.A.	N.A.
12	N.A.	N.A.	N.A.	N.A.
13	N.A.	N.A.	N.A.	N.A.
14	X		X	
15	X		X	
16	X		X	
17	X		X	
18	X		X	
19	X		X	
24	X		X	
25	X		X	
26	X		X	
27	X		X	
28	X		X	
29	X		X	
36	X		X	
37	X		X	
38	X		X	
39	X		X	
47	X			X
48	X			X
49	X			X
57	X			X
58	X			X
59	X			X
68		X		X
69		X		X
79		X		X

Illuminator detail view

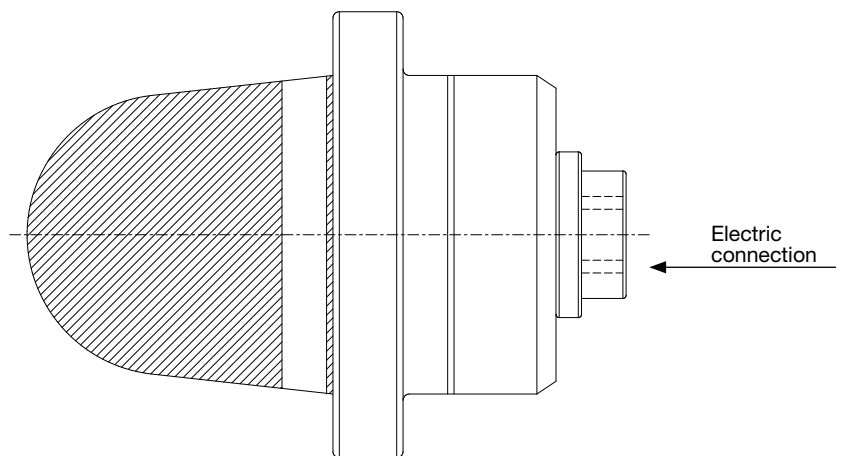

ILLUMINATOR mod. EVA50

TECHNICAL DATA:

- galvanized carbon steel fixing plate (from stainless steel on request)
- aluminium body with epoxy coating
- transparent cover from borosilicate glass
- 42W type E27 halongen lamp
- Max. supply voltage 230V a.c.
- certificate: Exd IIC T6 T85°C or Exd IIC T3 T200°C
ATEX II2GD IP65
INERIS 01ATEX 0068X
- electrical connections: standard ¾ UNI 6125
Others on request via a certified adaptor
- diffuser: plexiglass (Tmax 150°C)
pirex (Tmax 320°C)

OPTION

- LED lamp



GENERAL FEATURES SHARED BY ALL MODELS:

- The connections between the level and the cocks are made by screwed nipples (NY or YY) or by end tubes and stuffing boxes (NX or YX).
- Gauge connections 1/2"
- The position of the lever cock handles can be Right or Left.
- Process connections can be flanged (UNI - ANSI - DIN), threaded (GAS M / F - NPT M / F) and Socket Welding (SW).
- Graphoil gasket.
- The carbon steel body is galvanized by electrolysis.
- Body painted can be supplied on request.
- Suitable for interface service.

HOW TO ORDER

MODEL					
PN 40	PN 64	PN 100	PN 160	PN 250	PN 64 - Large chamber
TBB	TMC	TAC	THC	THH	TLC

	SIZE												
	see table												
	<table border="1" style="width: 100%; margin: 0 auto;"> <tr> <th colspan="4">CONNECTIONS</th> </tr> <tr> <td style="text-align: center;">Threaded nipples</td> <td style="text-align: center;">End tubes and stuffing boxes</td> <td style="text-align: center;">Threaded nipples for high pressure</td> <td style="text-align: center;">Union nipple (rotatable) for high pressure</td> </tr> <tr> <td style="text-align: center;">NY/YY</td> <td style="text-align: center;">NX</td> <td style="text-align: center;">YY</td> <td style="text-align: center;">YX</td> </tr> </table>	CONNECTIONS				Threaded nipples	End tubes and stuffing boxes	Threaded nipples for high pressure	Union nipple (rotatable) for high pressure	NY/YY	NX	YY	YX
	CONNECTIONS												
	Threaded nipples	End tubes and stuffing boxes	Threaded nipples for high pressure	Union nipple (rotatable) for high pressure									
	NY/YY	NX	YY	YX									
<table border="1" style="width: 100%; margin: 0 auto;"> <tr> <th colspan="3">BODY MATERIAL</th> </tr> <tr> <td style="text-align: center;">Carbon Steel</td> <td style="text-align: center;">AISI 316</td> <td style="text-align: center;">A350 gr.6</td> </tr> <tr> <td style="text-align: center;">A</td> <td style="text-align: center;">J</td> <td style="text-align: center;">LF2</td> </tr> </table>	BODY MATERIAL			Carbon Steel	AISI 316	A350 gr.6	A	J	LF2				
BODY MATERIAL													
Carbon Steel	AISI 316	A350 gr.6											
A	J	LF2											
<table border="1" style="width: 100%; margin: 0 auto;"> <tr> <th colspan="2">CONNECTIONS POSITION</th> </tr> <tr> <td style="text-align: center;">SIDE-SIDE</td> <td style="text-align: center;">TOP-BOTTOM</td> </tr> <tr> <td style="text-align: center;">LL</td> <td style="text-align: center;">TB</td> </tr> </table>	CONNECTIONS POSITION		SIDE-SIDE	TOP-BOTTOM	LL	TB							
CONNECTIONS POSITION													
SIDE-SIDE	TOP-BOTTOM												
LL	TB												
<table border="1" style="width: 100%; margin: 0 auto;"> <tr> <td style="text-align: center;">SPECIAL VERSION</td> </tr> <tr> <td style="text-align: center;">XX</td> </tr> </table>	SPECIAL VERSION	XX											
SPECIAL VERSION													
XX													

TBB	47	NY	A	LL	XX
------------	-----------	-----------	----------	-----------	-----------

The following data are also requested:
fluid, operating temperature and pressure and the connections distance.



OFFICINE OROBICHE S.p.A.

24010 Ponteranica (Bergamo) ITALY - via Serena, 10 - Tel. 0039.035.4530.211 - Fax 0039.035.570546

www.officineorobiche.it e-mail: info@officineorobiche.it

Information subject to change without prior warning